



USER MANUAL

objecto

Safety Information

- Before use, be sure to carefully read all information to ensure that you use this product correctly. Always follow this information when using this unit.

WARNING

Do not disassemble. This product may only be disassembled by qualified repair technicians.

Attempting to disassemble this product can cause a fire, electrical shock, or injury.

Do not use when the power cord or plug is damaged, or the plug is inserted loosely into the outlet.

This can result in an electrical shock, short-circuit, or start a fire.

Do not scratch, damage, modify, forcibly bend, pull, twist, or bind the power cord, or place heavy objects on or clamp the power cord.

This could damage the power cord and result in a fire or electric shock.

Do not insert metal objects, such as pins, wires, or other foreign objects in the gaps of this product.

This could result in an electrical shock or malfunction.

Do not allow children to use this product by themselves. Keep out of reach of small children.

Otherwise, burns, injury or electrical shock could result.

Use with the designated power supply only 110 – 120 V.

Otherwise, this could result in a fire or electrical shock.

CAUTION

When cleaning the product, be sure to unplug from the outlet as a safety measure.

Do not use in locations with high humidity (85% or higher).

The room could become wet, resulting in malfunction.

Do not use in locations where the steam mist directly contacts furniture, walls, curtains, ceiling, or other objects.

Do not place on slanted surfaces, high locations such as bookshelves, or on unstable surfaces.

Do not block the mist outlet.

Use clean water only.

Do not use hot water.

Use of water that is 104°F or higher can cause deformation or malfunction of the product.

Never put aroma oil or other fragrances directly into the water tank.

Do not place the product directly on a carpet or other object with soft fibers.

Do not wipe with benzene or thinner.

When unplugging the power cord, always unplug by grasping the power plug, not by pulling on the cord.

Spill out the water when not using the product.

Replace the water in the water tank and water tub with new clean water every day. Clean weekly to ensure that the inside of the product is always clean.

Do not place cell phones, computers, or other electronic devices near the product.

Because the area around the humidifier becomes moist when it is operating, do not place cell phones, computers or other electronic devices that are sensitive to humidity near the humidifier.

Be careful that the product does not freeze.

If the product is placed in a location subject to freezing temperatures, discard the water.

Place the product in a location that is at least 7 feet away from televisions, radios, and other electronics.

Do not tilt the product.

This appliance is not intended for use by persons (including children) with reduced physical, sensory or mental capabilities or lack of experience and knowledge unless they have been given supervision or instruction concerning use of the appliance by a person responsible for their safety.

Children shall not play with the appliance.

Cleaning and user maintenance shall not be done by children without supervision.

If the supply cord is damaged, it must be replaced by the manufacturer, its service agent or similarly qualified persons in order to avoid a hazard.

Names of Parts and Their Functions

Front

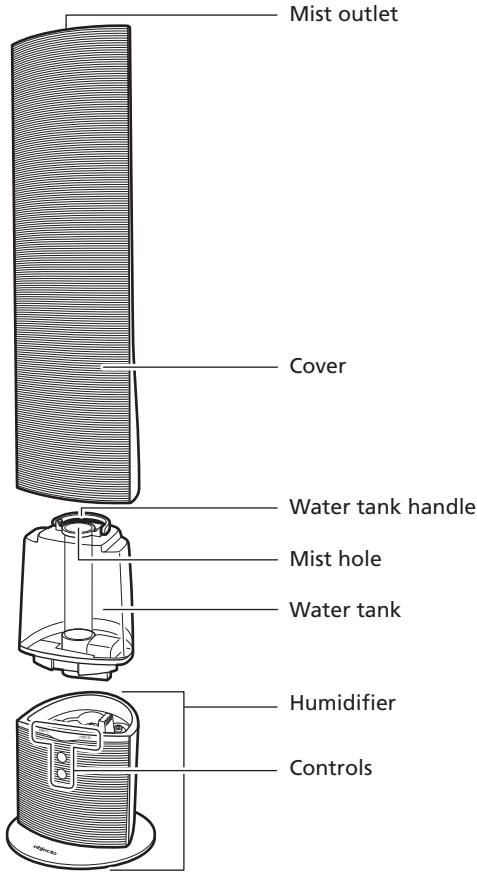

Water tank back side

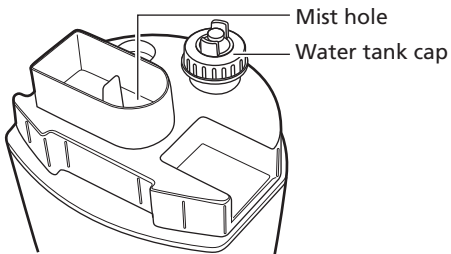

Back

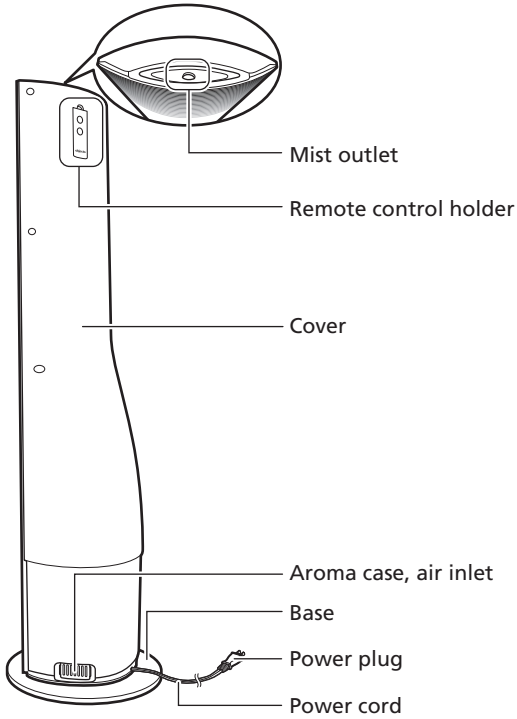

Inside of body

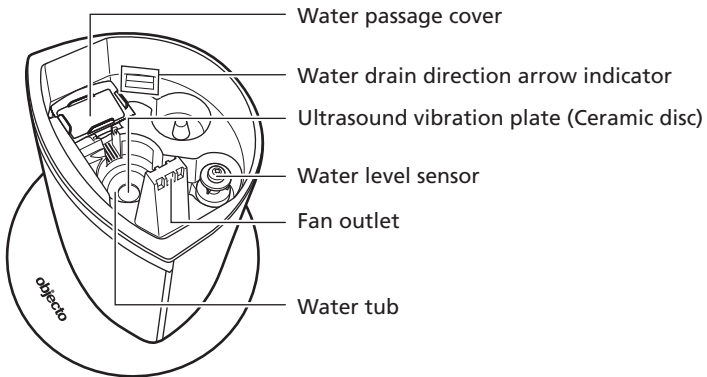

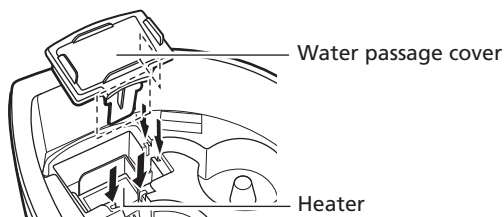

* If the water passage cover is not attached correctly, hot water can overflow from the humidifier body.

Insert the tabs at the bottom of the water passage cover (dotted line section) all the way into the grooves of the water passage in the humidifier body (shown by the arrows).

Accessories

Remote control

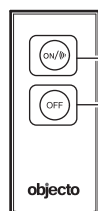

Power/Mist Setting button

OFF button

* The two buttons on the remote operate the same as the two buttons on the humidifier.



Coin-shaped lithium battery (CR2025)

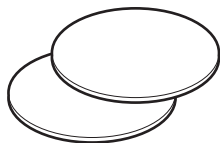

Replacement felt x 2

CAUTION

- Never put aroma oil or other fragrances directly into the water tank. This could damage the humidifier or cause malfunction.
- Before moving the humidifier, remove the water tank and spill out the water inside in the direction indicated by the arrow. Otherwise, the water in the tank and humidifier body could spill.
- Be sure that the water passage cover is always attached when using. Use without attaching the cover could result in a water spill. Do not remove the cover unless cleaning the humidifier.
- When draining the water, be sure to drain it in the direction indicated by the arrow. Draining the water in a different direction may let water get into the fan outlet and can result in malfunction.

Correct Use of the Hybrid Humidifier

Preparing the Remote Control for Use

1. Inserting a Battery

- 1 Turn the remote control over and hook your finger under the part indicated by ↓ in the diagram and pull out the battery holder.
- 2 Insert the battery with the +/- oriented correctly.
* Insert the battery into the holder with the + facing up.
- 3 Slide the battery holder back in.
* Press it in all the way.

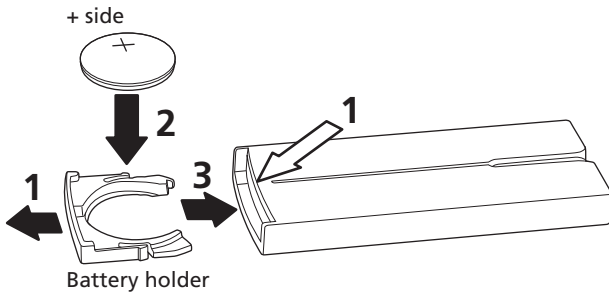

CAUTION

- To get more life out of the battery, remove it when not using the remote for a long time.
- Insert the battery correctly to prevent damage and/or leaking.
- Never recharge, short, disassemble, heat or throw a battery into a fire.
- If a leak should occur, wipe off the battery holder thoroughly and insert a fresh battery.

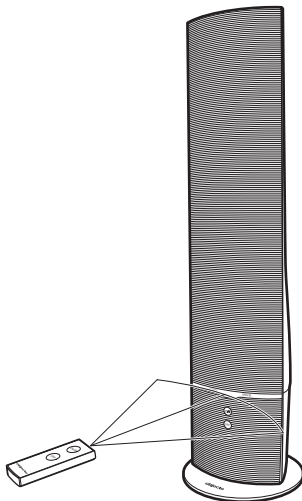

Usable Range

- 17 feet in a straight line from the front of the humidifier
- About 30 degrees to either side of the front of the humidifier
- The remote control may not work correctly if there is an obstruction between it and the humidifier

- When not in use, attach to the back of the cover.

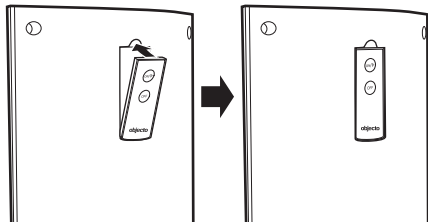

* Hold the cover securely while attaching it to keep the humidifier from falling over.

Preparation Before Use

- Place the humidifier on a leveled, stable surface.

CAUTION

Place the humidifier at least 7 feet from televisions, radios, and other electronics. Otherwise, static interference can result.

- Fill with water.

- Remove the cover from the top of the humidifier.
- Remove the water tank from the humidifier, unscrew the water tank cap, and fill the tank with clean tap water at room temperature.
- Firmly tighten the water tank cap, wipe up any spilled water, and check that no water is leaking.

CAUTION

- Use clean tap water only.
- If refilling the water after using the humidifier, water drops inside the cover may spill when removing the cover. Have towels on hand so the humidifier and floor do not get wet.

- Set the water tank into the humidifier so that it fits securely.

- Load the water tank into the humidifier, and put the cover securely on the humidifier.

WARNING

If you are going out or will be away from the humidifier for a long time, unplug the power cord from the outlet.

- Plug the power cord into the outlet.

Keep the humidifier an appropriate distance from walls and surrounding objects

Pay attention to the following points when using the humidifier.

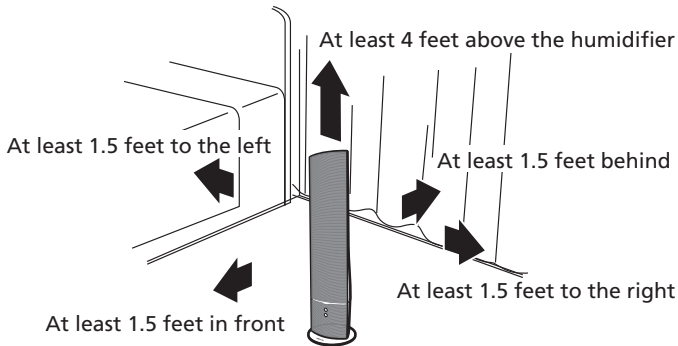

- Use the humidifier in a location that is at least 1.5 feet away from walls, bedding, curtains, furniture, and other objects.
- Do not place on carpets or other materials with a soft fibres. These could cause a malfunction of the device or leaks to the surrounding area.
- Never place cell phones, computers, or other electronic or precision devices that are sensitive to humidity near the humidifier.

Starting, Mist Settings and Stopping the Humidifier

1. Start the humidifier

When the Power/Mist Setting button  is pressed, the mist level indicator lights up green and the humidifier starts producing mist after about 2 minutes.

* To prevent water from accumulating at the mist outlet, the fan motor slows for 2 seconds about every 20 seconds.

CAUTION

- When going to bed during the winter, if the heater is turned off and the room temperature drops below 59°F, continued misting operation can result in condensation. Because this can cause the hybrid humidifier body and the floor to become wet, if using in environments where the room temperature is expected to drop below 59°F or the humidity is expected to be above 60% when going to bed, either set misting operation to L (Low) or SL (Min.), or stop misting operation.
- Even if the Power/Mist Setting button  is pressed immediately after the water indicator turns off, the hybrid humidifier does not produce mist for about two minutes. This is because the water temperature is heated to at least 140°F for sterilization before starting the misting operation.

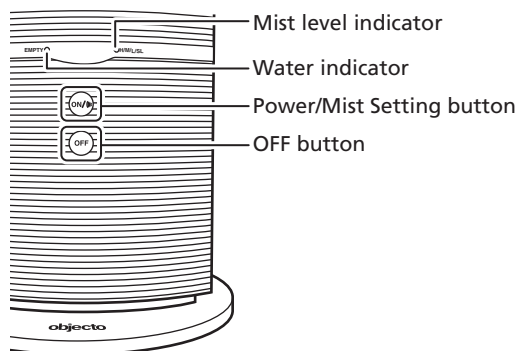

2. Set the mist level

To set the mist level, press the Power/Mist Setting button . Each time the button is pressed, the setting cycles from H (High) → M (Medium) → L (Low) → SL (Super Low). The indicator is green when set to H (High), blue when set to M (Medium) or orange when set to L (Low) and it flashes orange when on SL (Super Low).

* The humidifier should normally be used on any setting except H (High). Using it on H (High) may create excessive humidity. Be careful when using it on high.

H (High) → M (Medium) → L (Low) → SL (Super Low)

Mist setting	Mist level indicator color
H (High)	Lit green
M (Medium)	Lit blue
L (Low)	Lit orange
SL (Super Low)*	Flashes orange

* Timer function

Press the Power/Mist Setting button  and when it is set to SL (Super Low), it activates the timer function, which automatically turns the power off after 5 hours.

3. Stop the humidifier

Press the OFF button  to stop operation.

* After misting stops, the fan runs for about 1 minute before the humidifier comes to a complete stop.

If the Water indicator turns red during operation

When the Water indicator is lit red, it indicates that the water level in the water tank is low.

When the water level in the water tank is low, the alarm beeps five times and the Water indicator lights up red.

- 1 After draining any water remaining water in the tank, refill the tank with new clean water.
- 2 When water reaches the humidifier from the water tank, the Water indicator turns off.
- 3 Press the Power/Mist Setting button  to start operation.

CAUTION

If water needs to be refilled, the alarm beeps five times, and the Water indicator lights up red. Refill the water tank.

Using the Aroma Case

1. Pull out the aroma case from the humidifier body.

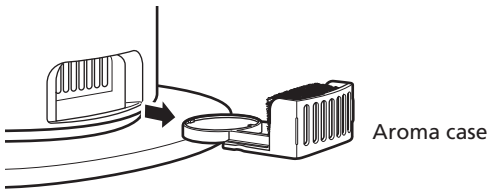

2. Dampen the felt in the case with aroma oil and put it back in the body of the humidifier.

Check that the felt is inserted in the aroma case. Drop two or three drops of aroma oil or essential oil (available commercially) while being careful that it does not spill outside the case. Next, insert the aroma case all the way into the humidifier.

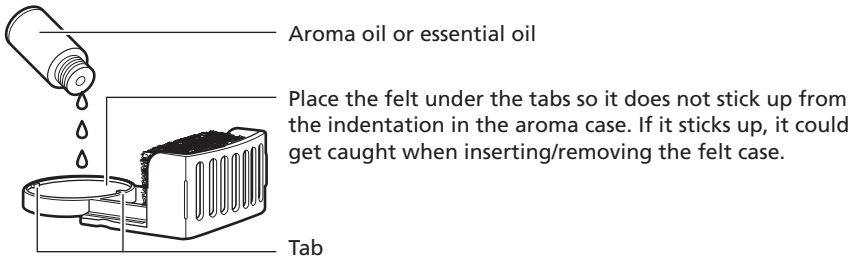
**CAUTION**

- Do not pour too much aroma oil or essential oil so that it overflows from the aroma case.
- Always wipe up any aroma oil or essential oil if it spills outside the aroma case.
- Do not insert the aroma case into the humidifier while aroma oil or essential oil is spilled outside the aroma case.
- Do not use with any felt other than that supplied with this humidifier.
This could damage the humidifier or cause malfunction.

3. Start the humidifier

Start the humidifier according to the procedures on page 9, "Starting, Mist Settings and Stopping the Humidifier". Enjoy the mist that now has an aromatic fragrance. If aroma oil or essential oil is not added, it can be used as a regular humidifier.

Replacing the Felt

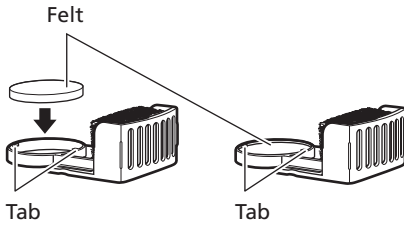

- * Replace the felt whenever it becomes dirty, or when using a different scented aroma or essential oil.
- * In addition to the felt that comes in the aroma case at purchase, two additional pieces are also included.
- * The felt cannot be washed and used again.
- * Insert the felt so that it fits under the tabs in the aroma case.
- * Wash the aroma case with a neutral detergent, and carefully wipe up any moisture before inserting it into the aroma base by following step 2.

Handling of aroma and essential oils

- Do not expose oils to open flame.
- Store out of the reach of children.
- If oils are spilled on clothes or other objects, rinse with a lot of water and allow to air dry. Do not use a dryer. Doing so could cause the object to ignite.
- If any oil gets on your hands, wash them immediately.
- For further details about handling aromatic and essential oils, refer to the instructions that come with them.

Cleaning and Storage

WARNING

- After taking out the water tank, do not touch the metal parts inside the humidifier. Doing so could result in injury or malfunction.
- Before cleaning, always stop operation, unplug the power cord, and allow the inside of the humidifier to cool (about 10 minutes). Otherwise, an electrical shock, burn, or other injury could occur.
- After cleaning, always remount the parts in their original locations. Otherwise, an injury or malfunction could result.

Cleaning the Humidifier (at least twice a week)

Fully drain the water left inside the humidifier.

- * When draining the water, be sure to drain it in the direction of the arrow shown on the humidifier body.
Draining the water in a direction different from the direction of the arrow can result in malfunction.

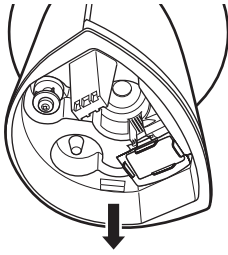

Drain direction

When the body gets dirty, wipe it clean with a soft cloth dipped in warm water and/or dish detergent and well wrung out. Then polish it gently with a dry cloth. (Do not rub hard on the plastic parts. Doing so may scratch them.)

- * If the water passage cover was removed, be sure to reattach it. Otherwise, this can cause a water leak.

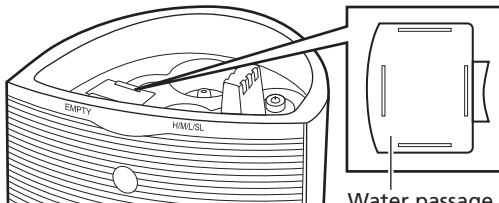

Always attach the water passage cover when using.

Water passage cover

- * If the water passage cover is not attached correctly, hot water can overflow from the humidifier body. Insert the tabs at the bottom of the water passage cover (dotted line section) all the way into the grooves of the water passage in the humidifier body (location shown by the arrows).

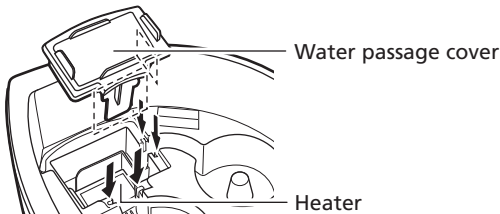

- * Drain the water, and dry thoroughly.
- * Use a vacuum cleaner or other method to clean off any dust on the air inlet of the aroma case.
- * Remove any dust on the filter installed in the aroma case by washing it off with water. (Do not rub or wring out too strongly. Doing so may damage it.)

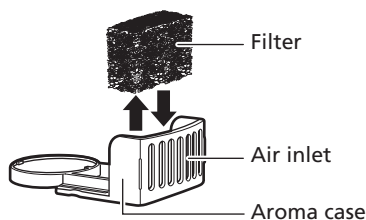

Cleaning the Water Tank (at least twice a week)

Fill up the water tank with water, close the water tank cap, thoroughly shake the water tank, and then drain. (Repeat this two or three times.)

- * Be sure to always wash the water tank with water at room temperature. Washing the water tank with hot water can cause it to deform. Do not wash with cleansers or other solvents. These substances can cause the humidifier to malfunction.

CAUTION

- Do not wipe with benzene or thinner. This could result in discoloration or deformation.
- Before using a cloth containing chemical substances, check its safety information. Otherwise, discoloration or scratches could result.
- Replace the water in the water tank with new clean water every day. Clean regularly to ensure that the inside of the product is clean.
- Only use clean water. Do not use distilled water.
- Never use juice or other drinking fluids, hot water (104°F or higher), or water mixed with chemical products, fragrances (such as aroma oil), or cleanser.

Before Requesting Repairs or Service

WARNING

This product can be disassembled and repaired by qualified repair technicians only. If you find any problems, follow the troubleshooting procedures below.

Problem	Primary Cause	Solution
The power does not turn on.	<ul style="list-style-type: none"> The power cord is not plugged into the outlet. 	Plug the power cord into the outlet.
No or very little mist is produced.	<ul style="list-style-type: none"> The Water indicator lit red. 	Fill with water. * Even if you press the Power/Mist Setting button  immediately after the Water indicator turns off, the humidifier does not produce mist for about 2 minutes. This is because the water temperature is heated to at least 140°F for sterilization before starting the misting operation.
	<ul style="list-style-type: none"> The ceramic disc must be replaced. * The ceramic disc has an expected service life of about 3,000 hours. 	If the service life of the ceramic disc is exceeded, the amount of mist generated can drop or fail to be generated at all. When the ceramic disc needs to be replaced, contact the service center (a charge applies for replacing it).
The Water indicator stays lit red even when water is supplied.	<ul style="list-style-type: none"> The water tank is not mounted to the humidifier securely. 	Load the water tank so that it fits properly.
An odor is emitted.	<ul style="list-style-type: none"> Using water other than clean water. 	Drain the water left in the water tank, and clean by following the procedure in "Cleaning and Storage".
The mist seems like it stops every 20 seconds.	<ul style="list-style-type: none"> This is not a malfunction. To prevent water from accumulating at the mist outlet, the fan motor cycles on for at least 2 seconds every 20 seconds. 	This is normal operation, and it is not a malfunction.

Specifications

Product name	W9 Tower Hybrid Humidifier
Model	HW-54
Power supply	110 – 120 V, 50/60 Hz
Rated consumption	80 W
Mist production	Per hour: H (High): Approx. 0.64 pints, M (Medium): Approx. 0.50 pints , L (Low): Approx. 0.31 pints , SL (Super Low): Approx. 0.20 pints
Continuous humidifying time	Approx. 8 hrs. in High mode (H) Approx. 11 hrs. in Medium mode (M) Approx. 18 hrs. in low mode (L) Approx. 28 hrs. in Super Low mode (SL)
Tank capacity	Approx. 0.69 gallons
Power cord length	Approx. 6 feet
External dimensions	Approx. 9 inches Dia. × 34 inches H.
Weight	Approx. 5 lb (body only)
Accessories	User's Manual / warranty × 1, Remote control × 1, Coin-shaped lithium battery (CR2025) for remote control × 1, Replacement felt × 2

* Due to a continuous process of product improvement, the specifications and other information are subject to change without notice.

LIMITED WARRANTY POLICY

Thank you for selecting our Products.

Please carefully read the User's Manual furnished with this product. We believe that you will be very satisfied with your purchase. We will provide the following LIMITED WARRANTY to you as the original purchaser.

Should service be necessary for any reason due to manufacturing defect or malfunction during the 90 days period, OBJECTO will provide carry-in repair service at our FACTORY SERVICE CENTER at no charge, and for the duration of the extended 9 months parts warranty period will replace the defective part only, not including labor, provided the defect or malfunction is verified along with the date of purchase. In the event service is necessary, you may return the unit to our FACTORY SERVICE CENTER listed below.

- a) Pack the unit in a well padded heavy corrugated box. Be certain that the unit is well protected.
- b) Enclose your check or money order payable to OBJECTO REPAIR CORP, in the amount of \$40.00.
- c) Enclose copy of proof of purchase.
- d) Ship the unit prepaid via UPS or parcel post insured.

NOTE: This warranty does not cover.

- a) OBJECTO products which have been damaged by negligence, misuse or accident or which have been modified or repaired by anyone other than our FACTORY SERVICE CENTER.
- b) Damage to OBJECTO equipment that has been improperly connected to the equipment of other manufacturers
- c) Costs incurred in the shipping of OBJECTO products to our FACTORY SERVICE CENTER.

This warranty is valid only to the original purchaser and does not extend to owners of the product subsequent to the original purchaser. Any applicable implied warranties, including the warranty of merchantability, are limited in duration to a period of 90 days from the date of original purchase at retail and no warranties, whether expressed or implied, shall apply to this product thereafter. Under no circumstances shall OBJECTO be liable for any loss or damage, direct or consequential, arising out of the use of, or inability to use this product. (Some states do not allow limitation or implied warranties or exclusion of consequential damage, therefore these restrictions may not apply to you.)

This warranty gives you specific legal rights and you may also have other rights which may vary from state to state.

- a) The Limited Warranty Registry Card must be completely filled out and mailed immediately, in order to validate the Limited Warranty.
- b) You must include copy of your purchase slip when you are returning the unit.

Register your new product online at WWW.OBJECTO.com

SERVICE INFORMATION:

OBJECTO

935 BROADWAY, 6TH FL.

NEW YORK, NY 10010

TELEPHONE: (844) OBJECTO (844-625-3286)

FAX: 800-433-9099

WWW.OBJECTO.COM