

# Sanidyne<sup>®</sup> PREMIUM

ULTRAVIOLET PORTABLE AREA SANITIZER

Amalgam Remote Controlled Sanitizer

## Installation, Operation & Maintenance

Read and Follow All  
Safety Instructions.  
Save These Instructions.



 SINCE 1963  
**ATLANTIC ULTRAVIOLET**  
CORPORATION<sup>®</sup>

Manufacturers / Engineers / Sales / Service  
Germicidal Ultraviolet - Equipment & Lamps

375 Marcus Boulevard • Hauppauge, NY 11788  
631.273.0500 • Fax: 631.273.0771  
Email: Sales@AtlanticUV.com  
Ultraviolet.com • BuyUltraviolet.com

Extensive Product Information Available at:

**Ultraviolet.com**  
**BuyUltraviolet.com**



# Owner's Manual

# TABLE OF CONTENTS

<b>SAFETY WARNINGS</b> .....	<b>3</b>
<b>SAFETY INSTRUCTIONS</b> .....	<b>3</b>
SAFETY LABELS .....	4
CAUTION .....	4
<b>PRODUCT APPLICATIONS</b> .....	<b>5</b>
CONSTRUCTION .....	5
PRINCIPLE OF OPERATION .....	5
LIMITATIONS .....	5
<b>UNPACKING</b> .....	<b>6</b>
<b>INSTALLATION</b> .....	<b>6</b>
DIMENSIONAL DATA .....	6
REAR VIEW OF UNIT .....	7
KEYPAD CONTROLLER OVERVIEW .....	7
HAND-HELD REMOTE CONTROLLER OVERVIEW .....	8-9
LAMP INSTALLATION .....	9-10
UNIT PLACEMENT .....	10
<b>UNIT OPERATION</b> .....	<b>10</b>
PRE-OPERATION .....	10
<b>Sanidyne® Premium</b> OPERATION .....	11
USING THE KEYPAD CONTROLLER TO SET TREATMENT TIMES .....	11
USING THE HAND-HELD REMOTE CONTROLLER TO SET TREATMENT TIMES .....	11-12
SETTING DATE AND TIME .....	12
SAVING A SESSION .....	12
DETERMINING TREATMENT TIME FOR ROOM SIZES .....	13
<b>MAINTENANCE</b> .....	<b>14</b>
MAINTENANCE OVERVIEW .....	14
GERMICIDAL LAMP INSTALLATION, REPLACEMENT, OR CLEANING .....	14
LAMP BREAKAGE .....	14
DISPOSAL OF MERCURY ADDED LAMP .....	14
<b>TROUBLESHOOTING</b> .....	<b>15</b>
<b>TECHNICAL SPECIFICATIONS</b> .....	<b>15</b>
<b>OPTIONAL ACCESSORIES</b> .....	<b>16</b>
<b>REPLACEMENT PARTS</b> .....	<b>16</b>
<b>MAINTENANCE LOG</b> .....	<b>17-19</b>
<b>USER ASSISTANCE</b> .....	<b>20</b>
PATENT NOTICE .....	20
<b>WARRANTY &amp; PRODUCT REGISTRATION</b> .....	<b>20</b>

These instructions generally describe the installation, operation and maintenance of the **Sanidyne® Premium** Portable Area Sanitizer. Questions that are not specifically answerable by these instructions should be directed to the factory. Atlantic Ultraviolet Corporation® takes all possible precautions when packaging equipment to prevent damage. Carefully inspect and report all damages. Do not install damaged equipment. Follow all instructions on any labels or tags. Carefully inspect all packing materials before discarding to prevent the loss of accessories, mounting hardware, spare parts or instructions.

The information and recommendations contained in this publication are based upon data collected by the Atlantic Ultraviolet Corporation® and are believed to be correct. However, no guarantee or warranty of any kind, expressed or implied, is made with respect to the information contained herein. Specifications and information are subject to change without notice.





# SAFETY WARNINGS

- All personnel should be alerted to the potential hazards indicated by the product safety labeling on this unit.
- The following conventions are used to indicate and classify precautions in this manual and on product safety labeling. Failure to observe precautions could result in injury to people or damage to property.

 This is the safety alert symbol. It is used to alert you to potential personal injury hazards. Obey all safety messages that follow this symbol to avoid possible injury or death.

 **DANGER** Danger indicates an **IMMINENTLY** hazardous situation, which, if not avoided, **WILL** result in death or serious injury.

 **WARNING** Warning indicates a **POTENTIALLY** hazardous situation, which, if not avoided, **COULD** result in death or serious injury.

 **CAUTION** Caution indicates a **POTENTIALLY** hazardous situation, which, if not avoided, **MAY** result in minor or moderate injury.

 **CAUTION** Caution used without the safety alert symbol indicates a potentially hazardous situation, which, if not avoided, may result in property damage.

 This symbol is used to identify an **ELECTRICAL SHOCK** or **ELECTROCUTION** hazard.

 This symbol is used to identify an **ULTRAVIOLET LIGHT** hazard.

 This symbol is used to identify the need to wear approved ultraviolet blocking eyewear.







 This symbol is used to identify the need to wear approved ultraviolet blocking face shield.

 This symbol is used to identify the need to wear protective gloves.

 This symbol is used to identify components which must not be disposed of in trash

# SAFETY INSTRUCTIONS

 **WARNING** To guard against injury, basic safety precautions should be observed, including the following:

1. Read and follow ALL safety instructions.
2.    **WARNING** Avoid exposure to direct or reflected germicidal ultraviolet rays. Germicidal ultraviolet rays are harmful to the eyes and skin.
3. Intended for indoor use only.
4. Do not alter design or construction.
5. Do not use this sanitizer for other than its intended purpose, as described in this manual.
6. Do not use this sanitizer in occupied areas. The supplied “**DANGER - DO NOT ENTER...**” sign(s) **MUST** be clearly displayed to warn against entering the area during the disinfection cycle without proper personal protection equipment.
7.  **CAUTION** Germicidal ultraviolet rays may break down plastic, rubber or other non-metallic materials, with inadequate resistance to ultraviolet. Shield all plastic, rubber or other non-metallic parts which may be exposed to direct or reflected germicidal ultraviolet rays.
8. Do not remove any labels.
9.  **WARNING** Do not operate without proper electrical ground.
10. Do not operate the sanitizer if the power cord and/or plug are damaged, or if any other damage to the sanitizer is visible or suspected.
11. Utility power supplied to the sanitizer, **MUST** match power requirements listed on the sanitizer label.
12.  **WARNING** Always disconnect power to the fixture before performing any service or maintenance.
13. Read and follow all notices and warnings on the sanitizer.
14. **SAVE THESE INSTRUCTIONS.**

# SAFETY LABELS

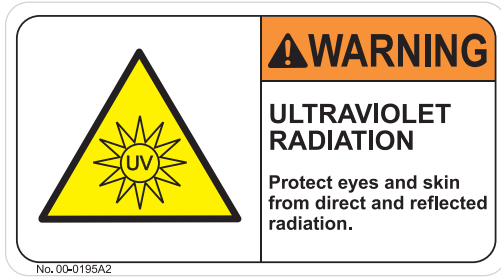

Danger Label: Ultraviolet Radiation (00-0195A2)



Location of Danger Labels (00-0195A2) on Top of Unit

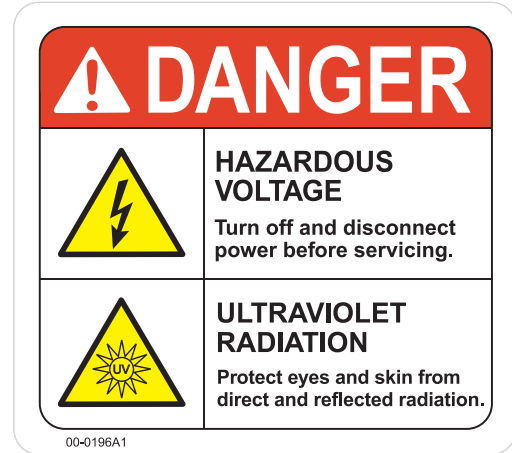

Danger Label: Hazardous Voltage / Ultraviolet Radiation (00-0196A1)

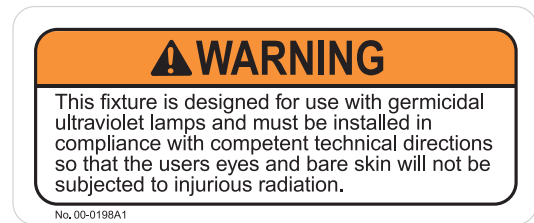

Warning Germicidal UV Label (00-0198A1)

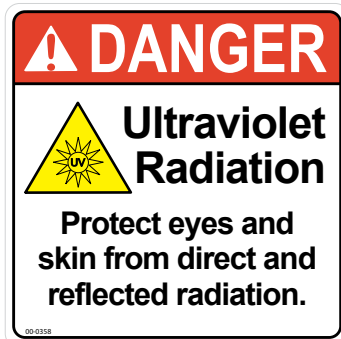

Danger Label: Ultraviolet Radiation (00-0358)



Location of Danger Labels (00-0358) on Both Sides of Unit

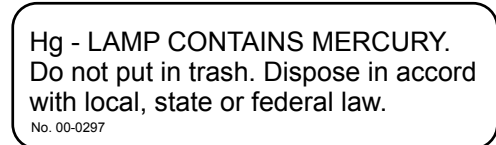

Hg-Lamp Contains Mercury Label (00-0297)



Location of Danger Labels (00-0196A1, 00-0198A1, and 00-0297) on Back of Unit

## CAUTION

It is the user's responsibility to determine and validate the suitability of this equipment for use in the user's system or process. No warranty or representation is made by the manufacturer with respect to suitability or performance of this equipment or to the results that may be expected from its use. The user should periodically inspect, clean as necessary and confirm the presence and good legibility of the product safety labels. Contact the factory for replacement labels in the event that any of the labels are missing or illegible.

# PRODUCT APPLICATIONS

---

## CONSTRUCTION

---

The **Sanidyne® Premium** Portable Area Sanitizer consists of:

- **STER-L-RAY® Amalgam Germicidal Ultraviolet Lamps:** Deliver ultraviolet energy at the specific wavelength of 254 nanometers (nm). This wavelength is highly effective against microbes including virus, bacteria and mold spores. Germicidal ultraviolet rays are harmful to eyes and skin, avoid exposure of direct or reflected germicidal ultraviolet rays without approved ultraviolet blocking face shield and protective covering (such as gloves, long sleeves with no gaps between cuff and gloves).
- **Audible Exit Warning Alarm:** To alert area that the lamps will be powered on in one minute and thirty seconds after the start button is pressed or to indicate intruder is in Operation Area.
- **Elapsed Time Indicator:** A non-resettable display of the operating hours. Useful for scheduling and recording maintenance and lamp replacement.
- **Hand-Held Remote Controller:** Provides easy operation of **Sanidyne® Premium** from a safe distance, displays lamp operation, controls treatment times and alerts operator with an audible alarm if an intruder enters Operation Area.
- **Keypad Controller:** Provides easy operation of **Sanidyne® Premium** and allows the operator a period of time (one minute and thirty seconds) to leave the Operation Area before treatment begins.
- **Intruder Sensors:** Delay treatment if the Operation Area is inhabited. Additionally if sensors detect an intruder with less than 30 seconds left before lamps operate, the countdown time will automatically restore back to 30 seconds until area is cleared.
- **Four Wheels with Locking Casters:** Make moving **Sanidyne® Premium** easily accomplished for location changes.
- **Power Cord:** For 120v AC 50/60Hz single-phase standard household current, a NEMA 5-20, three-prong plug is provided for a properly grounded outlet. (Consult factory for other plug types).
- **Stainless Steel Lamp Guard Assembly:** Protects lamps from damage during normal operation.
- **Stainless Steel Construction:** All electronics and wiring are housed in an enclosure constructed of stainless steel, providing strength and durability in order to withstand most harsh environments.
- **Cooling Fans:** Circulate cool, clean air to ensure all electronics are operating at optimum temperatures.
- **Sanidyne® Premium** will operate at 120v 50/60Hz.

## PRINCIPLE OF OPERATION

---

The **Sanidyne® Premium** design has been carefully conceived to provide direct germicidal ultraviolet exposure for air and surface disinfection in **unoccupied** areas to disinfect and prevent areas and surfaces from microorganisms. The ultraviolet disinfection dosage is a function of time and the intensity, of the ultraviolet radiation to which the air and surrounding surfaces are exposed.

**NOTE:** The **Sanidyne® Premium** should be used as a supplement to your facility's cleaning and disinfection protocols, not as a replacement. Follow your facility's cleaning and disinfection protocols before using the **Sanidyne® Premium**.

No special room preparation is required prior to treating a room or area with the **Sanidyne® Premium** — however, target surfaces must be directly exposed to the UV rays. These rays will not penetrate materials like cloth, paper or ordinary glass, therefore, it is important to remove items from the direct line of sight that would block or shield the rays from other surfaces. The **Sanidyne® Premium** does not generate any harmful byproducts, nor does it leave any residual substances.

**⚠ CAUTION** It is the user's responsibility to determine and validate the suitability of the equipment for use in system or process. No warranty or representation is made by the manufacturer with respect to suitability or performance of this equipment or to the results that may be expected from its use.

**⚠ CAUTION** Indoor Use Only – The equipment must be sheltered from exposure to the elements and extremes in temperature. Temperature range: 40 °F to 95 °F. The user should periodically inspect, clean as necessary and confirm the presence and good legibility of the Product safety labels. Contact the factory for replacement labels in the event that any of the labeling is missing or illegible.

**⚠ CAUTION** The UV Treatment Results achieved are subject to variations in application conditions, it is recommended that culture tests be performed to confirm desired outcomes.

## LIMITATIONS

---

- Safety procedures **MUST** be implemented to prevent ultraviolet exposure of occupants to direct or reflected ultraviolet rays. Exposure to germicidal ultraviolet rays will result in the irritation of the eyes and reddening of the skin.



Personal protection equipment is required when entering the irradiated space with the germicidal lamp(s) operating. Personal protection equipment includes skin and eye protection such as gloves, long sleeves with no gaps between cuff and gloves, and an ultraviolet blocking face shield (included with the purchase of the **Sanidyne® Premium**).

# UNPACKING



IN ORDER TO PERFORM THIS TASK, BE SURE TO WEAR THE FOLLOWING SAFETY EQUIPMENT: SAFETY GLASSES OR A FACE SHIELD, AS WELL AS GLOVES

- Remove the **Sanidyne® Premium** from its shipping carton.
- Atlantic Ultraviolet Corporation® takes all possible precautions when packaging this fixture to prevent damage. Carefully inspect the unit, power cord and plug for damage, report all damage immediately. Do not assemble or operate if there is any damage, visible or suspected.
- **STER-L-RAY®** Germicidal Ultraviolet Lamps are packed separately, to ensure maximum protection. Keep the lamps aside until ready for installation.
- Carefully inspect all packing materials to prevent the loss of accessories, spare parts or instructions.
- Do not discard packing materials until **Sanidyne® Premium** is assembled, checked and confirmed.

The **Sanidyne® Premium** Portable Area Sanitizer includes:

- 1 - Eight-lamp fixture with power cord - Includes a microprocessor controller with time display and push button controls
- 1 - Hand-Held Remote Controller
- 8 - **STER-L-RAY®** Amalgam Germicidal Ultraviolet Lamps (05-0250) with **ArmorLite™** Protective Coating
- 2 - **Promate™** Ultraviolet Blocking Face Shields with Adjustable Headgear
- 1 - Owner's Manual
- 4 - **Promate™** Laminated Warning Signs

# INSTALLATION

Figure 1 – Dimensional Data

All specifications, dimensional data, etc are approximate and subject to change without notice.

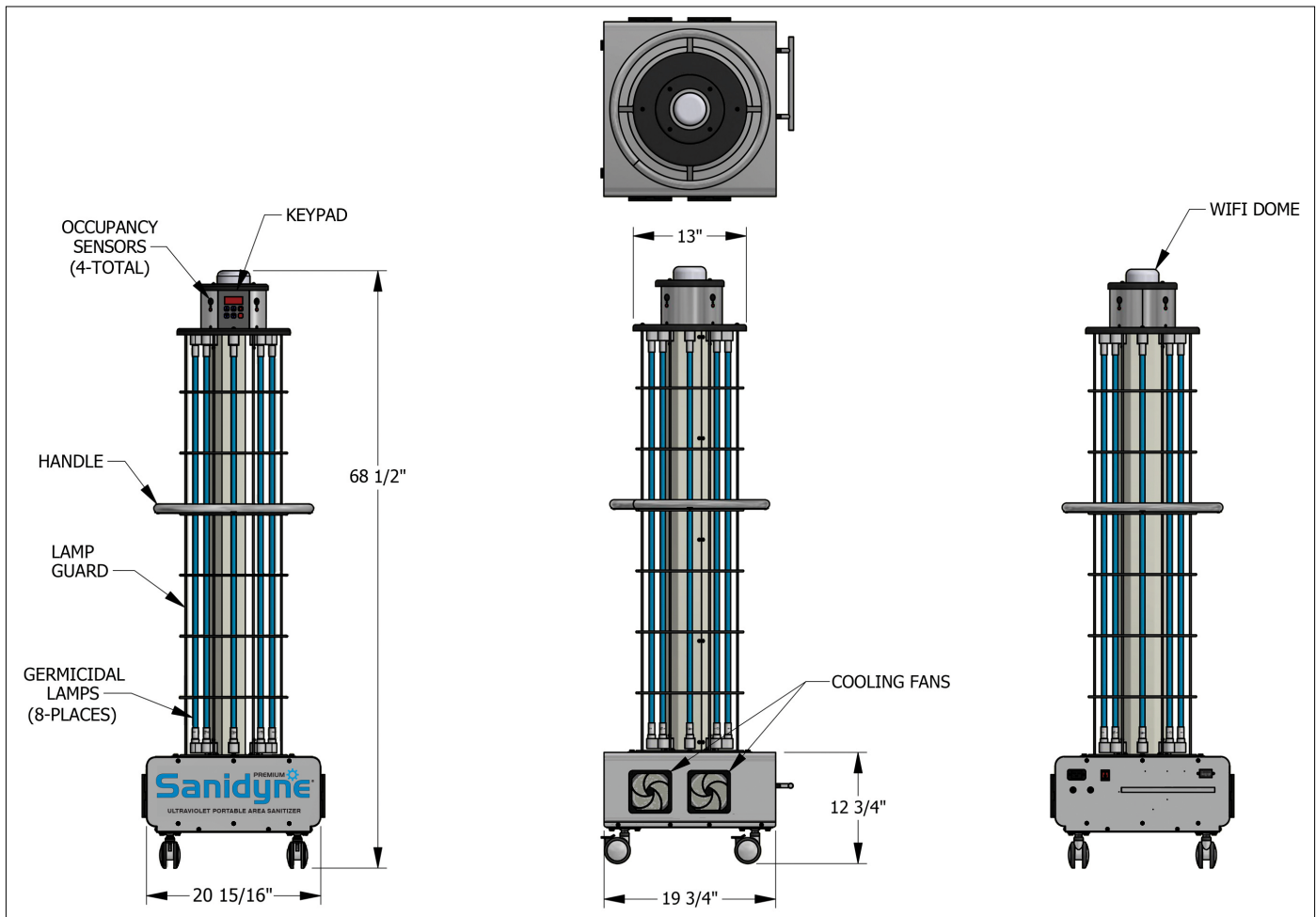
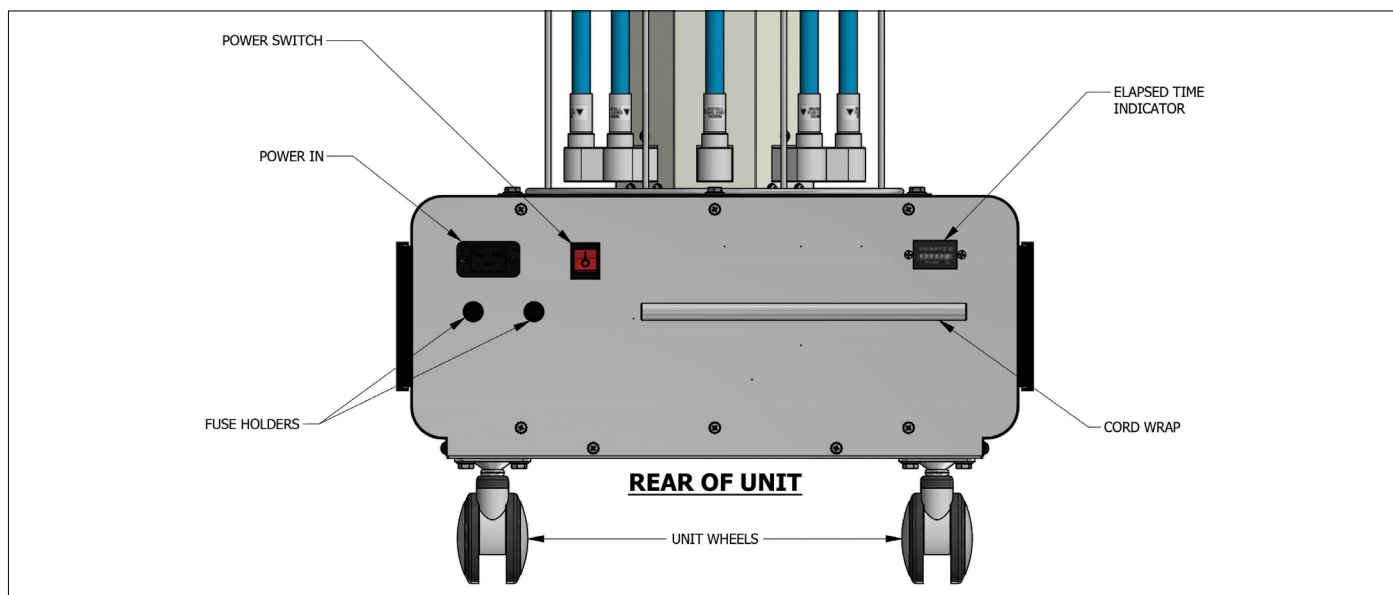
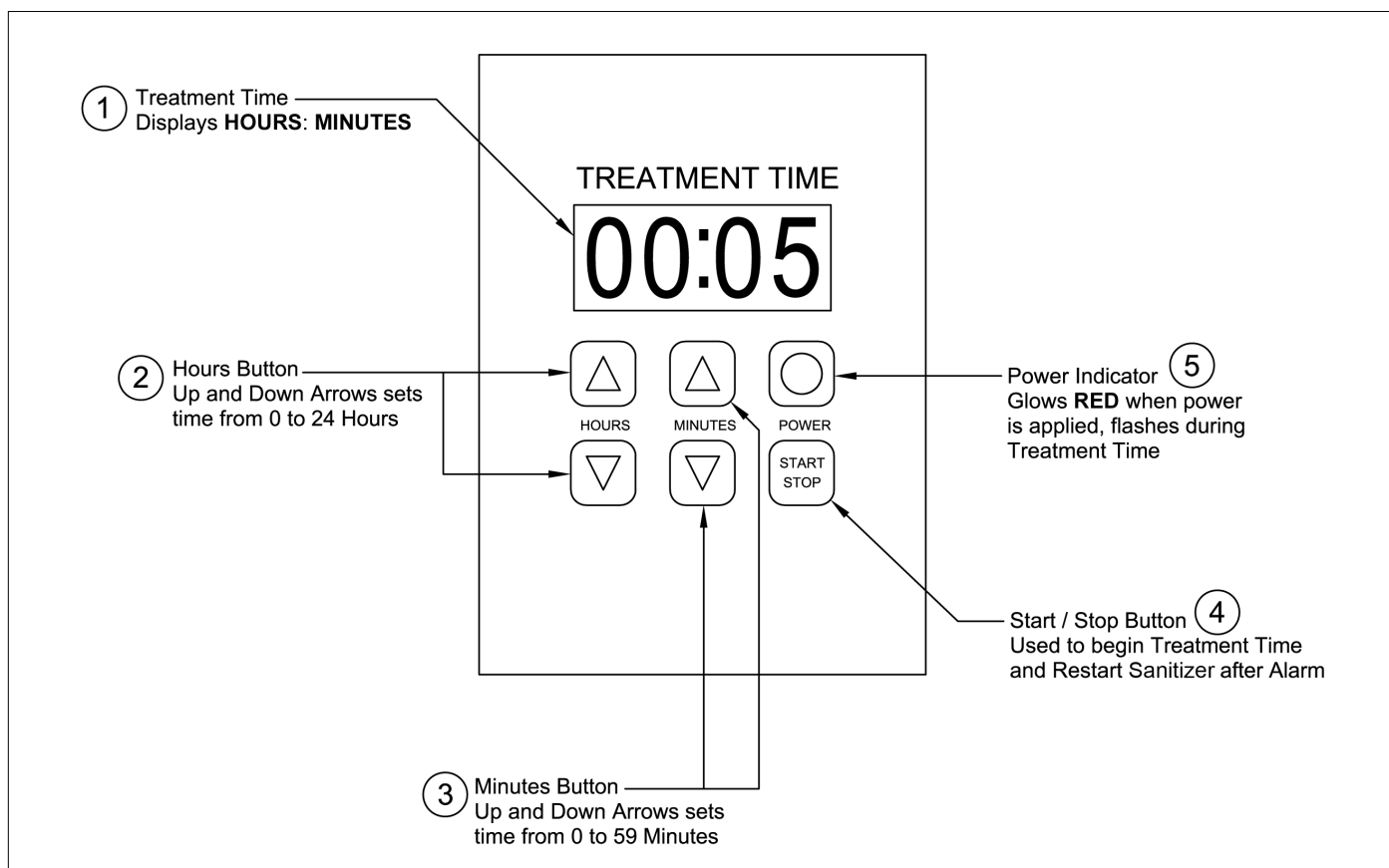

Figure 2 – Rear View of Unit



## KEYPAD CONTROLLER OVERVIEW

Figure 3 – Keypad Controller Overview



1. **Treatment Time:** Displays chosen treatment time which will countdown after start is selected. Flashes with word “PREP” during Countdown Time, the word “RUN” during Treatment Time and “DONE” when Treatment Time is completed.
2. **Hour Buttons:** Up and down buttons are used to select treatment hours between 0 and 24.
3. **Minute Buttons:** Up and down buttons are used to select treatment minutes between 0 and 59.
4. **Start / Stop Button:** Begins treatment time countdown, also used to restart unit after an intruder is sensed in Operating Area.
5. **Power Indicator:** Glows **RED** when power is applied to unit and will flash during Treatment Time. Flashes rapidly if occupancy sensor is tripped

# HAND-HELD REMOTE CONTROLLER OVERVIEW

Figure 4 – Hand-held Remote Controller Overview

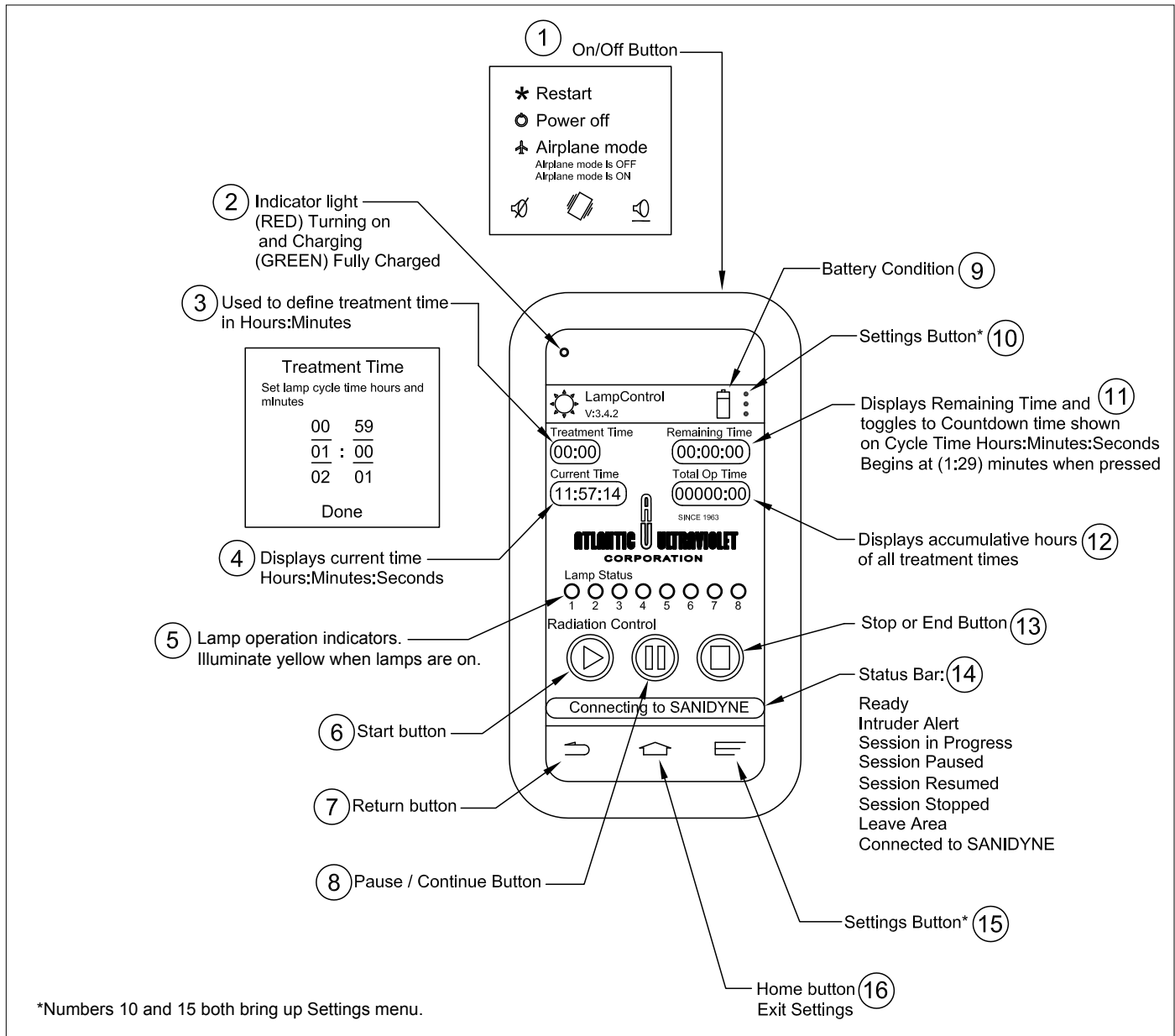

**General Rule of Selection:** Except for the **ON/OFF** button located on the top-right edge of the Hand-held Remote Controller, all selections made to this device will require a gentle touch of a short period of time to achieve a response.

1. **ON/OFF Button:** Turns the power to the device on or off and can be used to restart the device. The **ON/OFF** button will require the button to be pushed in, and held until the red light on the top left lights; vibration of the device is felt. Contains choice to: Restart / Power Off / Airplane Mode; ON – OFF (**MUST BE SET TO ON AT ALL TIMES**). Additionally displays three icons at bottom which are Sound Off / Vibrate / Sound On.
2. **Indicator Light:** Glows **RED** when the device begins to turn on and during device charging. Turns **GREEN** when fully charged.
3. **Treatment Time:** Set treatment time in Hours, Minutes. Hold finger on **Treatment Time** to select until menu changes to scroll bar. Scroll the numbers up or down, positioning the times chosen in the center row. When times are positioned correctly, select “**DONE**” on the screen to input your Treatment Time choice.
4. **Current Time:** Displays current time in Hours, Minutes, Seconds. Can be reset under **SETTINGS**, however this requires a PIN Number to do this. (See “**Setting Date and Time**” on Page 12)
5. **Lamp Operation Indicators:** Lamp status glows yellow when the lamps are operating correctly. If lamp is not operating the lamp status will be displayed grey for that lamp. (**Remote Overview Continued on Page 9**)



6. **Start Button:** Starts treatment cycle time.  
Once selected:
  - a) Remaining Time changes to Countdown Time and begins counting down from 1 minute 29 seconds, allowing time for operator to leave area.
  - b) The words “**LEAVE AREA**” appear on the lower status bar.
  - c) Alarm on unit begins to sound
  - d) The word “**PREP**” flashes on the Keypad during the Countdown Time, when Treatment Time begins the word “**RUN**” flashes and when the treatment time is completed the word “**DONE**” will appear.
7. **Return Button:** Brings you back to previous screen
8. **Pause / Continue Button:** Used to pause the treatment time, or to continue the treatment time. This button toggles from the **Pause Icon**, which is displayed as two vertical bars to the **Continue Icon** which is a looping arrow. If pause is selected below 30 seconds during the Countdown, the Countdown time will reset to 30 seconds. If pause is selected during the treatment time, the device will provide an additional 1 minute 29 seconds of countdown time, allowing operator to leave area.
9. **Battery Condition:** Displays the charge level of the battery in the hand-held remote. Press on battery symbol to see percent of charge.
10. **Settings Button:** Contains choices for:
  - a) Settings: Reset Operating Time or Clear Session Data
  - b) Set Date/Time: requires a PIN to reset (See “**Setting Date and Time**” on Page 12)
  - c) Sessions: Log of saved sessions
11. **Remaining Time:** Displays remaining time of treatment and toggles to (Countdown time shown on Treatment in Hours, Minutes, Seconds) when selected.
12. **Total Operation Time:** Displays accumulative hours of all treatment times.
13. **Stop or End Button:** Stop treatment time.
14. **Status Bar:** Outputs all the conditions of the device
  - a) Ready
  - b) Intruder Alert
  - c) Session in Progress
  - d) Session Paused
  - e) Session Resumed
  - f) Session Stopped
  - g) Leave Area
  - h) Connected to **Sanidyne®**
15. **Settings Button:** Same as (10) above.
16. **Home Button:** Exit Setting

## **LAMP INSTALLATION**

**⚠ WARNING** Always disconnect power to the fixture before performing any service or maintenance.

**⚠ CAUTION** Germicidal lamps are easily damaged. Exercise care when handling lamps.



**Step 1** – Remove Top Cover by removing all hardware and place on the side to be reinstalled later.

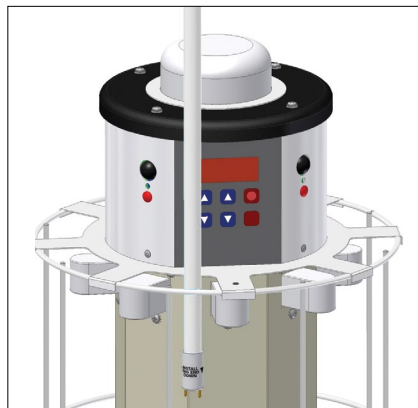

**Step 2** – One end of lamp is marked “**INSTALL THIS END DOWN.**” Carefully fit this end of the lamp into the lamp guard assembly first, as shown.

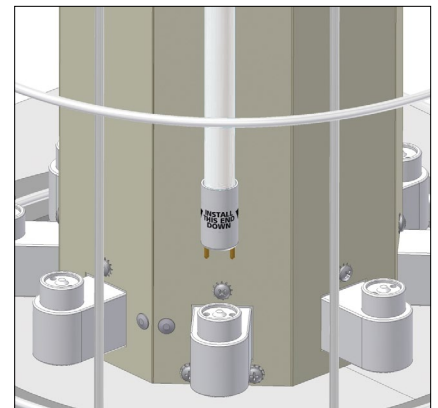

**Step 3** – Carefully align pins on lamp base to socket holes on lamp holder as shown. (**Lamp Installation Continued on Page 10.**)

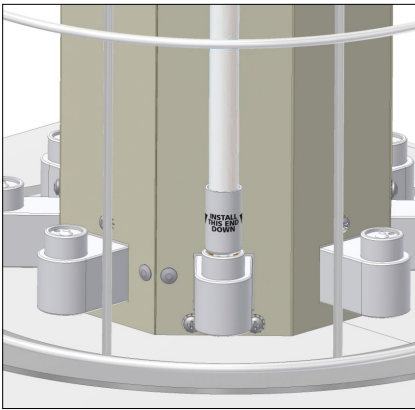

**Step 4** – Using the lamp, apply slight pressure to compress the lower lampholder, and then pivot the lamp so it aligns with the top lamp socket. Lamp should appear straight when lamp is correctly in place. Confirm pins are inserted and both ends align.

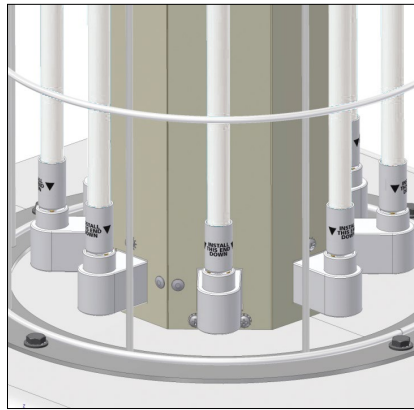

**Step 5** – Repeat until all lamps have been installed.

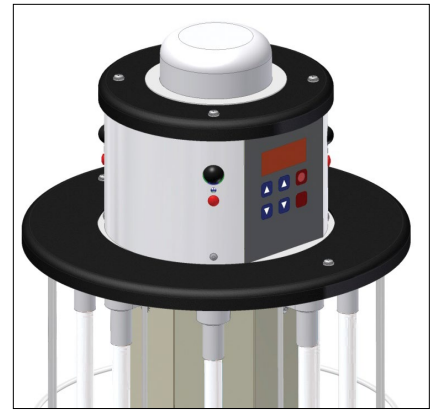

**Step 6** – Once complete, reinstall Top Cover.

## UNIT PLACEMENT

- The **Sanidyne® Premium** is intended for indoor use only. It should be protected from liquid intrusion such as dripping water, condensation or mist, and used only in a clean, dry location with temperature ranges between 40 °F to 95 °F.
- Electrical power supplied to the **Sanidyne® Premium** must match power requirements listed on the **Sanidyne® Premium**.
- **⚠ CAUTION** The **Sanidyne® Premium** is intended for use in **UNOCCUPIED AREAS ONLY**. Under no circumstances should this sanitizer be permitted to operate with humans, plants, or animals present in the Operation Area.
- The intrusion sensors will detect movement if anyone is in the treatment area and the lamps will be switched off until fixture is reset by pressing the **START/STOP** button on keypad on the top of the **Sanidyne® Premium**.
- For maximum efficiency the **Sanidyne® Premium** should be located as centrally as possible, away from the corners of the treatment area. The **Sanidyne® Premium** Portable Area Sanitizer is most effective when it is located in the vertical center of the room and the ultraviolet rays are unobstructed.

## UNIT OPERATION

### PRE-OPERATION

1. Fully charge the Hand-held Remote Controller (Shown in **Figure 4**). **NOTE:** Charger provided operates on 100 volt to 240 volts 50/60Hz and has a NEMA 1-15 plug.
2. Once a location has been chosen for the **Sanidyne® Premium** post Laminated Warning Signs supplied with the **Sanidyne® Premium** on all access doors to the area where treatment operation will take place.

**⚠ WARNING** It is the users responsibility to post signs, or notices for all personnel and persons in the building or facility so that they be made aware that the Operation Area is off limits during treatment.

3. **⚡** Connect the **Sanidyne® Premium** to a properly grounded outlet power source which matches the power requirements listed on the **Sanidyne® Premium** (See Power In location shown on **Figure 2- Rear View of Unit**)

**⚠ CAUTION** Approved Promate™ Face Shields (2), are supplied with each unit. Promate™ Face Shield **MUST** be worn prior to the next step by the operator as well as anyone else in the operation area. In addition the operator and anyone present **MUST** use protective gloves and clothing to protect skin from UV rays.



4. Turn power on using the Power Switch located on the rear of the **Sanidyne® Premium** (See Power Switch location shown on **Figure 2 - Rear View of Unit**). Switch will glow **RED** when power is on. Once fixture receives power, the **RED** lights located just below the Occupancy Sensors on the top of the fixture will glow **RED**. (See Occupancy Sensors (4-Total), shown on **Figure 1 - Dimensional Data**). This is not a warning, it indicates that the sensors are aware of your presence.

## **SANIDYNE® PREMIUM OPERATION**

---

The **Sanidyne® Premium** has two methods of controlling the fixture; the Keypad Controller (Shown in **Figure 3**) and the Hand-held Remote Controller (Shown in **Figure 4**). These two controls mirror each other; treatment times entered into Keypad Controller will appear on the Hand-held Remote Controller and vice versa.

### **USING THE KEYPAD CONTROLLER TO SET TREATMENT TIMES**

---

1. Setting Treatment Time on the Keypad is done using the **HOURS** and **MINUTES** buttons which is located on the top of the **Sanidyne® Premium**. (See **Figure 1** for location) Selecting the up or down facing arrows located on the keypad in line with the **HOURS** or **MINUTES** button will either increase or decrease the hours or minutes. The hours can be set between 0 and 24, and the minutes can be set from 1 to 59. (Example of one hour and five minutes would appear as 01:05 on the Treatment Time Display). Since the Keypad Controller will no longer be viewable once the treatment time begins, it is recommended that the Hand-held Remote Controller be fully charged and powered before this time and be in possession of the operator at all times.
2. Determining the proper treatment times for your specific location can be done by using the “**Recommended Treatment Time for Room Size**” chart (**Figure 5** on **Page 13**).
3. Once the choice of time has been displayed on the Keypad controller, select the **START/STOP** button to begin and leave the Operation Area immediately. Make sure that the Hand-held Remote Controller is kept in possession of the operator during the Treatment Time.

Once you select the **START/STOP** button an audible exit alarm will begin to sound and the **Sanidyne® Premium** will begin counting down from 1:30 seconds to allow all inhabitants to leave the area before the UV treatment begins. Additionally the word “**PREP**” will begin flashing on the Keypad. The occupancy Sensors located on the top of the **Sanidyne® Premium** (Shown on **Figure 1**) provide an additional safety area around the unit will begin to operate. As an additional safety feature, if the sensors detect movement close to the **Sanidyne® Premium** when less than 30 seconds remain on the countdown time, the **Sanidyne® Premium** will automatically reset giving 30 seconds more to leave the Operation Area.

**⚠ CAUTION** Occupancy Sensors do not protect the entire Operation Area of the **Sanidyne® Premium**. Under no circumstances should this sanitizer be permitted to operate with humans, plants, or animals present in the Operation Area.

4. Outside the Operation Area the Treatment Time can be viewed on the Hand-held Remote Controller. Once the treatment time has expired the **Sanidyne® Premium** will turn off the **STER-L-RAY®** Germicidal Ultraviolet Lamps and it is now safe to return to the area. The word “**DONE**” will begin flashing on the Keypad Controller on the top of the fixture.

### **USING THE HAND-HELD REMOTE CONTROLLER TO SET TREATMENT TIMES**

---

The Hand-held Remote Controller provides further detailed information on the **Sanidyne® Premium**. Therefore it is recommended to review the Hand-held Remote Controller Overview section of this manual to become familiar with the display which is shown in **Figure 4**.

**⚠ CAUTION** The Hand-held Remote Controller can operate the **Sanidyne® Premium** remotely, thus it is imperative that the operator make a visual inspection of the Operation Area to ensure it is clear of all humans, plants, or animals before proceeding.

1. Setting Treatment Time on the Hand-held Remote Controller is done by holding a finger on the display face, directly on the words Treatment Time until the screen changes to a scroll bar. Next scroll the numbers up or down, characters on the left are hours, characters on the right are minutes. Positioning the desired treatment time in the center row. (Example of one hour and five minutes would appear as 01:05 on the Treatment Time Display) When times are positioned correctly, select Done on the bottom of the scroll bar to input your Treatment Time choice.
2. Determining the proper treatment times for your specific location can be done by using the “**Recommended Treatment Time for Room Size**” chart (**Figure 5** on **Page 13**).
3. Once the choice of time has been displayed on the Hand-held Remote Controller, select the start button to begin and leave the Operation Area immediately. Make sure that the Hand-held Remote Controller is kept in possession of the operator during the Treatment Time. (**Remote Controller Instructions Continued on Page 12**)

**NOTE:** Once you select the start button an audible exit alarm will begin to sound and the **Sanidyne® Premium** will begin counting down from 1:30 seconds to allow all inhabitants to leave the area before the UV treatment begins. The words “Leave Area” will now appear on the lower status bar of the Hand-held Remote Controller. (See Figure 4, for the specific location). The occupancy Sensors located on the top of the unit (Shown on Figure 1) provide an additional safety area around the sanitizer will begin to operate at this time. If the sensors detect movement close to the **Sanidyne® Premium** when less than 30 seconds remains on the countdown time, the **Sanidyne® Premium** will automatically reset giving 30 seconds more to leave the Operation Area. The Countdown time as well as the Treatment Time will all be displayed on the Hand-held Remote Controller. See Figure 4, for the specific location.

**⚠WARNING** Occupancy Sensors do not protect the entire Operation Area of the **Sanidyne® Premium**. Under no circumstances should this sanitizer be permitted to operate with human, or animals present in the Operation Area.

4. The Hand-held Remote Controller displays the Lamp Status; When the lamp operation indicators on the display glow yellow the lamp is on, when the lamp is off it displays grey. (See **Figure 4** to locate lamp operation indicators) Once the treatment time has expired the unit will turn off the Germicidal Ultraviolet Lamps and it is now safe to return to the area.

**⚠CAUTION** If at any time during the Treatment Time the Occupancy Sensors detect someone near the **Sanidyne® Premium**, the fixture will immediately turn off and send an alarm to the Hand-held Remote Controller and the **Sanidyne® Premium**. If this event occurs the alarm can be turned off on the remote by pressing anywhere on the display or at the **Sanidyne® Premium** by pressing the START/STOP on the Keypad. If the Alarm is turned off at the **Sanidyne® Premium** the operator can reset the fixture by pressing the START/STOP button on the keypad controller again to begin the 1:30 countdown to allow all inhabitants to leave the area. After the 1:30 has elapsed the **Sanidyne® Premium** will power on and complete the remaining Treatment Time left prior to the alarm.

If the Hand-held remote is used to stop the alarm, the operator must return to the area and ensure that the area is safe to proceed. Select the START/STOP button on the keypad controller to begin the 1:30 countdown to allow all inhabitants to leave the are. After the 1:30 has elapsed the **Sanidyne® Premium** will power on and complete the remaining Treatment Time left prior the alarm.

## ***SETTING DATE AND TIME***

---

1. Press the **Settings** Button.
2. Press **Set Date/Time**.
3. Press **Admin Pin**. Using keyboard enter Pin number 1234.
4. Press **Date** or **Time**.
5. Scroll in **Date** or **Time** by swiping the scroll bar.
6. Press **Done**. Then press **Home** button when finished.

## ***SAVING A SESSION***

---

Saving a Session: At the end of a Session or after a Session is Stopped the “**Save This Session**” box will appear.

**To save a Session;**

1. Press **Yes** under Save Session.
2. Press on **Note Entry**
3. Type in Session Notes, press **OK**

**Clearing Total Operating Time or Clearing Session Data:**

1. Press **Settings** Button
2. Press **Settings**
3. Press on the box next to “**Reset Total Operating Time**” and/or “**Clear Session Data.**”
4. Press **Home** Button

## DETERMINING TREATMENT TIME FOR ROOM SIZES

**⚠ CAUTION** The Sanidyne® Premium is intended for use in **UNOCCUPIED AREAS ONLY**. Under no circumstances should this unit be permitted to operate with humans, plants or animals present in the Operation Area. Consult our UV Application Specialists if you have any questions or need help with the Sanidyne® Premium.

1. The fixture should be located in the approximate center of the room and target surfaces must be directly exposed to the ultraviolet rays. It is important to remove items from direct line of sight that would block or shield UV rays from striking target surfaces. Depending on the configuration of the space, and what specific disinfection you are looking to achieve, it may be advisable to operate the **Sanidyne® Premium** on each side of large fixed objects (like a bed, or table, etc).
2. Measure the longest distance from the **Sanidyne® Premium** to the farthest wall. Use this length to compare to the Distance From Fixtures / Time (Minutes) shown on **Figure 5** below.
3. For example, if the distance from your fixture measures 15 feet, find the 15 foot mark on the bar chart for each time range. As the treatment time increase, dose increases. (**NOTE**: The number at the end of each bar is the expected dose for each time increment in millijoules per square centimeter.)
4. If a greater dose is required, increase treatment time.

**Figure 5 – Treatment Time and UV Dosage Based on Distance from Fixture – Sanidyne® Premium**

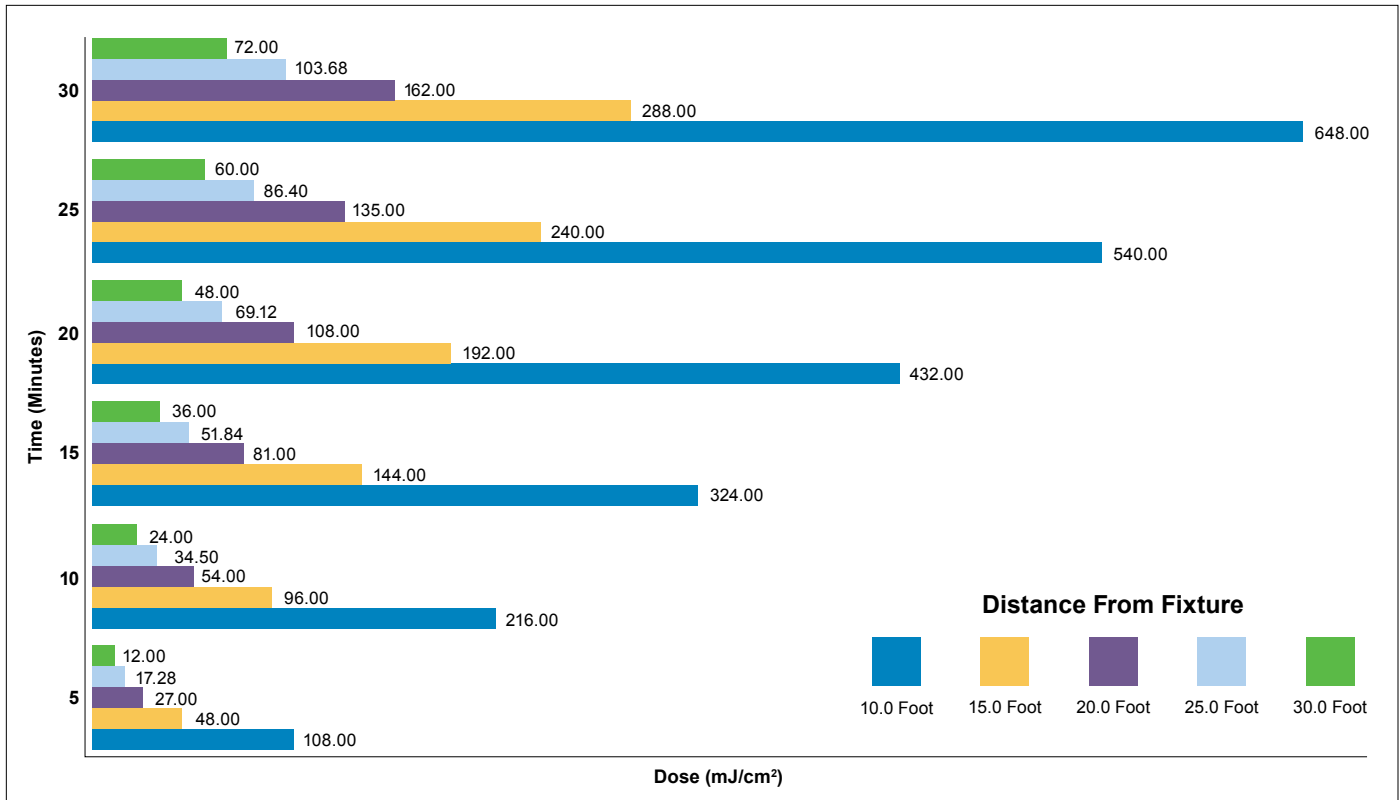

Note: Dose shown above is expressed as mJ/cm<sup>2</sup> (millijoule per square centimeter).

# MAINTENANCE

---



IN ORDER TO PERFORM THIS TASK, WEAR PERSONAL PROTECTION EQUIPMENT; GLOVES, LONG SLEEVE SHIRT WITH NO GAPS BETWEEN CUFFS AND GLOVES, AND AN ULTRAVIOLET BLOCKING FACE SHIELD MUST BE WORN TO COVER AND PROTECT EYES AND EXPOSED SKIN.

 **⚠️ WARNING** Always disconnect power to the fixture before performing any service or maintenance.

- A regular cycle of cleaning each **STER-L-RAY**® Germicidal Lamp **MUST** be established based on visual inspection and experience. The frequency of cleaning will vary with the conditions surrounding each installation. It is recommended that the germicidal lamp(s) and **Sanidyne**® Premium surfaces be cleaned at least once every three (3) months.
- The **STER-L-RAY**® Germicidal Lamp(s) used in the **Sanidyne**® Premium fixture have a manufacturer's rated average effective life of 13,000 hours. **STER-L-RAY**® lamps may operate longer than their rated effective life, but the reduction in ultraviolet output will make it impractical to use past the manufacturer's rated life. For maximum efficiency lamp replacement is recommended every 13,000 hours of operation.
- Unless lamp replacement is due to failure or breakage, it is recommended that all lamps be replaced at the same time.
- It is recommended that the user maintain a log of all maintenance performed on **Sanidyne**® Premium. (See Page 17.)



Personal protection equipment, such as gloves; long sleeves with no gaps between cuffs and gloves, and an ultraviolet resistant face shield, is required when entering the irradiated space.

## GERMICIDAL LAMP INSTALLATION, REPLACEMENT, OR CLEANING

---



IN ORDER TO PERFORM THIS TASK, WEAR PERSONAL PROTECTION EQUIPMENT; GLOVES, LONG SLEEVE SHIRT WITH NO GAPS BETWEEN CUFFS AND GLOVES, AND AN ULTRAVIOLET BLOCKING FACE SHIELD MUST BE WORN TO COVER AND PROTECT EYES AND EXPOSED SKIN.

**NOTE:** **STER-L-RAY**® lamps used in the **Sanidyne**® Premium have **ArmorLite**™ Safety Shield (which is a protective covering over the glass of the lamp—DO NOT REMOVE this covering.)

 **⚠️ WARNING** Always disconnect power to the fixture before performing any service or maintenance.

 **⚠️ CAUTION** Germicidal lamps are easily damaged. Exercise care when handling lamps.

1. To remove lamps follow the steps under “Lamp Installation” on Page 9 in reverse order.
2. Moisten a clean, lint-free cloth with denatured alcohol and wipe down the outer surface of the lamp.
3. When lamp has been removed and cleaned, then safely set aside, remove any loose dust or dirt from the surface of the fixture with a soft, dry cloth or vacuum.
4. To reinstall lamps follow the steps under “Lamp Installation” on Pages 9–10.
5. Re-install the top cover and tighten hardware as shown.
6. Reconnect **Sanidyne**® Premium to utility power, and restart.

 **⚠️ WARNING** Avoid exposure to direct or strongly reflected germicidal ultraviolet rays. Germicidal ultraviolet rays are harmful to the eyes and skin.

## LAMP BREAKAGE

---

 **⚠️ CAUTION** Broken Quartz is **SHARP**.



Wear protective gloves when handling broken ultraviolet lamps. In the event of breakage, **DO NOT** use a household vacuum cleaner to pick up fragments of the lamp. Sweep up debris into a plastic bag and dispose of in accordance with local and/or state regulations.

## DISPOSAL OF MERCURY ADDED LAMPS

---

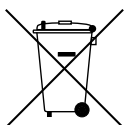

Germicidal ultraviolet lamps, like standard fluorescent lamps contain small amounts of mercury. Mercury added lamps should not be placed in the trash. Dispose of properly. For further information regarding the disposal and recycling of lamps containing mercury, along with Federal and State requirements visit [LampRecycle.org](http://LampRecycle.org). For more information on **STER-L-RAY**® Germicidal Ultraviolet Lamps, visit [Ultraviolet.com](http://Ultraviolet.com) or [BuyUltraviolet.com](http://BuyUltraviolet.com).

# TROUBLESHOOTING

**⚠️ WARNING** Always disconnect power to the fixture before performing any service or maintenance.



IN ORDER TO PERFORM THIS TASK, WEAR PERSONAL PROTECTION EQUIPMENT; GLOVES, LONG SLEEVE SHIRT WITH NO GAPS BETWEEN CUFFS AND GLOVES, AND AN ULTRAVIOLET BLOCKING FACE SHIELD **MUST** BE WORN TO COVER AND PROTECT EYES AND EXPOSED SKIN.

**IMPORTANT:** This fixture is to be serviced **ONLY** by qualified and factory authorized personnel.

Table 1 – Troubleshooting

Problem	Possible Cause	Corrective Action
<b>Sanidyne® Premium not operating</b>	Power disconnected	Check connections.
	Fuse not operating	Remove power connector to check and replace fuse if necessary.
<b>Lamp not operating</b>	<b>STER-L-RAY®</b> Germicidal lamp faulty	Swap suspect lamp, with lamp known to be good. If suspect lamp does not operate, replace lamp.
	<b>STER-L-RAY®</b> Germicidal lamp not properly seated	Check lamp socket and re-install lamp if necessary.
	Loose Connection	Inspect for loose or disconnected wires.
	<b>Surelite™</b> Ballast not operating	Disconnect the fixture from utility power; then replace ballast.
<b>Sanidyne® Premium fails to shut off</b>	Microprocessor assembly faulty	Wearing protective clothing and face shield, enter area, and disconnect power to unit. Call factory for technical service.
<b>Cooling fan not operating</b>	Fan failure	Check fan connections and replace if it does not operate.
<b>Low air flow through cooling fans</b>	Fan filter clogged	Remove filter and clean. Replace if filter appears worn or old.

# TECHNICAL SPECIFICATIONS

Table 2 – Technical Specifications

<b>Model:</b>	<b>40-5240B</b>	
<b>Voltage: (v)</b>	120v	
<b>Amperage: (A)</b>	16A	
<b>Hertz: (Hz)</b>	50/60 Hz.	
<b>Maximum Treatment Time: (Hours)</b>	24 Hours	
<b>Weight: (Pounds)</b>	76 lbs.	
<b>Dimensions:</b>	<b>Length: (Inches)</b>	21-3/4"
	<b>Width: (Inches)</b>	20-15/16"
	<b>Height: (Inches)</b>	68-1/2"
<b>Lamp Data:</b>	<b>Lamp Model:</b>	05-0250
	<b>Number of Lamps:</b>	8
	<b>Power Consumption: ① (Watts per Lamp)</b>	176W
	<b>Ultraviolet Output: ② (Watts per Lamp)</b>	60 UV Watts
	<b>Average Effective Life: (Hours)</b>	13,000 Hours

① Wattage is lamp watts only and does not include ballast loss.

② Ultraviolet output at 254nm at 100 hours and 80 °F (approximate).

All specifications, dimensional data, etc are approximate and subject to change without notice.

## OPTIONAL ACCESSORIES

---

1. **Zenith™ UV-C Detector:** A sensitive, hand-held, self-contained battery operated ultraviolet meter that can be used for:
  - Monitoring UV-C Germicidal Lamp Intensity & Aging
  - Measuring UV-C Germicidal Fixture Leakage.
2. **Promate™ Safety Glasses:** Safety eyewear **MUST** be used as general-purpose safety protection and for additional shielding from ultraviolet rays.
3. **Additional Promate™ Face Shields:** Lightweight visor with adjustable headgear provides eye and face protection from ultraviolet rays. Two (2) face shields are included with purchase of **Sanidyne® Plus** but additional face shields may be purchased.
4. **Additional Promate™ Warning Signs:** Laminated Danger Signs (8-1/2" x 11") to be affixed to entry door(s) to warn that an ultraviolet sanitizer is in use and that the treatment area **MUST** not be entered. Four (4) warning signs are included with purchase of **Sanidyne® Plus** but additional signs may be purchased.

For more information and purchasing contact our offices, weekdays between 8:30 am and 5:00 pm Eastern time, at:  
Atlantic Ultraviolet Corporation®, 375 Marcus Boulevard, Hauppauge, New York, 11788  
Tel: 631.273.0500 • Fax: 631.273.0771 • Email: Sales@AtlanticUV.com • Website: Ultraviolet.com – BuyUltraviolet.com

## REPLACEMENT PARTS

---

Table 3 – Replacement Parts

Item No.	Description	Part No.
1	<b>STER-L-RAY®</b> Germicidal Lamp	05-0250
2	<b>Surelite™</b> Ballast	10-0255
3	<b>Promate™</b> Face shield & Adjustable Headgear	00-0126
4	<b>Promate™</b> Warning Signs – Danger UV	00-0098
5	Cooling Fan Guard with Filter	40-1467
6	Line Cord—10ft, 20A	35-2122

Other replacement parts are available. Consult Atlantic Ultraviolet Corporation® for specific requirements.



# MAINTENANCE LOG

---

Date	Maintenance Performed	Service Person	Comment(s)

# MAINTENANCE LOG

---

Date	Maintenance Performed	Service Person	Comment(s)

**MAINTENANCE LOG**

<b>Date</b>	<b>Maintenance Performed</b>	<b>Service Person</b>	<b>Comment(s)</b>

# USER ASSISTANCE

---

Atlantic Ultraviolet Corporation® makes every effort to ensure that the **Sanidyne® Premium** Portable Area Sanitizer is a product of superior quality and workmanship. This manual describes the installation, operation and maintenance of the **Sanidyne® Premium** Portable Area Sanitizer.

Please read and become familiar with the contents of this manual before installing or using this unit. If after reading the manual you still have questions, or concerns, regarding the installation or use of this unit, contact our offices, weekdays between 8:30 am and 5:00 pm Eastern Time, at:

Atlantic Ultraviolet Corporation®  
375 Marcus Boulevard  
Hauppauge, New York, 11788  
Tel: 631.273.0500  
Fax: 631.273.0771  
Email: [Sales@AtlanticUV.com](mailto:Sales@AtlanticUV.com)  
Website: [Ultraviolet.com](http://Ultraviolet.com)  
[BuyUltraviolet.com](http://BuyUltraviolet.com)

## PATENT NOTICE

---

No attempt has been made to determine the patent status of applications illustrated or described in this publication. Inclusion in this publication of any design or method of use, which may be patented, is not to be construed as promoting or sanctioning unauthorized use.

# WARRANTY & PRODUCT REGISTRATION

---

**We warrant this product to the original owner to be free from defects in material and workmanship when installed in accordance with Atlantic Ultraviolet Corporation® specifications for a period of time as follows:**

**UV Water Purifier Chambers** – Type 316 stainless steel chambers will have a Twelve (12) year Limited Warranty on the stainless steel chamber, from the date of original purchase while the Type 304 stainless steel chambers will have a Six (6) year Limited Warranty on the stainless steel chamber.

**UV Air Disinfection Housing** – Three (3) year Limited Warranty on the metal housing, from the date of original purchase.

**Ballasts** – Three (3) year Limited Warranty, from the date of original purchase.

**UV Lamps, Monitoring Devices, Optional Accessories, and Other Parts** – One (1) year Limited Warranty from the date of original purchase.

Within the warranty period we shall repair or replace such products, which are returned to us with shipping charges prepaid and which are determined by us to be defective. This warranty will not apply to any product, which has been subjected to misuse, negligence or accident; or misapplied; or modified; or repaired by unauthorized person; or improperly installed. Warranty will be null and void if any of the product's original labels are removed. This Limited warranty excludes the cost of labor.

The Buyer shall inspect the product promptly after receipt and shall notify us at our main office in writing of claims, including claims of breach of warranty, within thirty (30) days after the Buyer discovers or should have discovered the facts upon which the claim is based. Failure of the Buyer to give written notice of a claim within the time period shall be deemed to be a waiver of such claim.

The provisions of the above warranty are our sole obligation and exclude all other remedies or warranties, expressed or implied, including warranties of merchantability and fitness for a particular purpose, whether or not purposes or specifications are described herein. We further disclaim any responsibility whatsoever to the customer, or to any person for injury to person, damage to, or loss of property or value caused by any product which has been subjected to misuse, negligence, accident; or modified or repaired by unauthorized persons; or improperly installed.

Under no circumstances shall the Company be liable for any incidental, consequential or special damages; losses or expenses arising from the contract for this product, or in connection with the use of, or inability to use, our product for any purpose whatsoever.

Be sure to register your product and validate purchase within 30 days — registration is simple and will take less than 2 minutes to do.

**NOTE – failure to register your purchase may jeopardize warranty.**

Go to [Ultraviolet.com](http://Ultraviolet.com) and scroll down to the bottom of the page, under “Trust” click the “Warranty Registration Form”, complete and click “Submit”. Or click on “Warranty Registration PDF” to download the warranty registration card as a PDF, complete and mail to us at 375 Marcus Boulevard, Hauppauge, NY 11788, or simply fax to 631-273-0771. If you prefer to register by phone, please call 631-273-0500 and our customer service staff will be glad to assist you.

For your convenience, record the following information below. The model and serial number can be found on a label located on the **Sanidyne® Premium** Portable Area Sanitizer. Keep this manual, along with proof of purchase, handy when contacting our offices.

Purchased From:	Date:
Model:	Serial No.: