

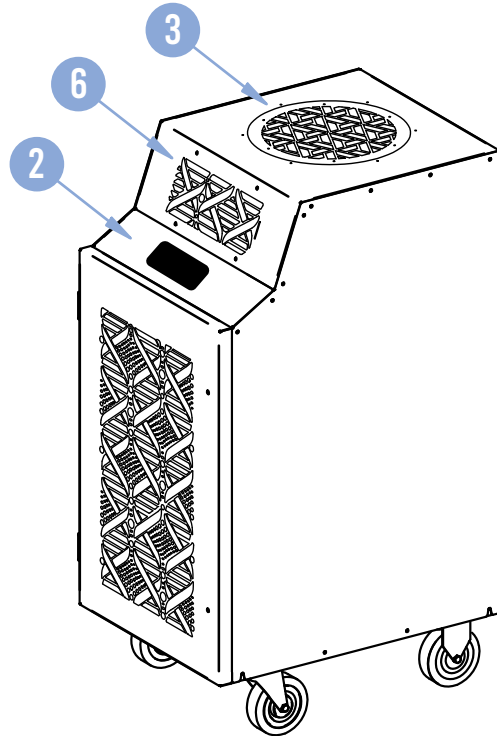

SPECIFICATIONS

KBP600

DESCRIPTION		
	600 CFM Combination Air Scrubber / Negative Air Machine	
AIR PURIFICATION		
	ULPA/HEPA Filter	99.97% @ > .3 Microns
	UVC Light Wave Length	UVC 30 Watts / Max 85 Watts x 2
FAN DATA		
	Fan Type (Centrifugal)	Direct Drive
	Air Flow (CFM)	600/500/400 - 3 Speed / Quad Directional
	Top Discharge Stainless Flange	8 In. / Optional 12 In.
	Optional CK-12S-SS Ceiling Kit	Optional 12" Dia. Ceiling Kit
ELECTRICAL DATA		
	Power Supply (Volts)	115 V / Single Phase
	Current Consumption (Amps)	5.14
	Power Consumption (kW)	0.6
	Maximum Circuit Breaker (Amps)	20
	Recommended Breaker Size	15
	Minimum Circuit Ampacity (Amps)	8.2
	Min/Max Voltage	105 - 125
	Power Cord Gauge / Length in Feet	14 AWG / 6'
	Plug Configuration	NEMA 5 - 15
DIMENSIONAL DATA		
	Width x Length x Height (inches)	16.5" x 22.25" x 38"
	Weight (lbs)	85
	Shipping Weight (lbs)	120
	Ceiling Kit - CK - 12SS (lbs)	12
	Total Shipping Weight w/ Ceiling Kit (lbs)	132
SAFETY DEVICE DATA		
	Fan Motor Overload	Automatic Internal
	Automatic Restart	Yes

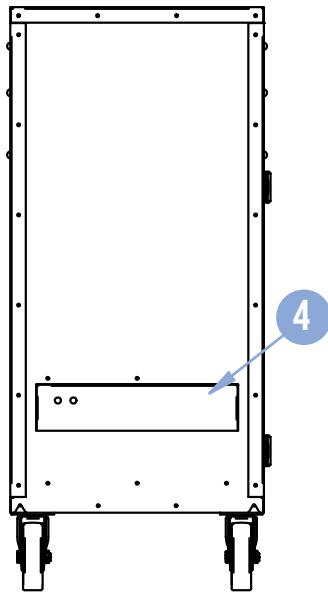
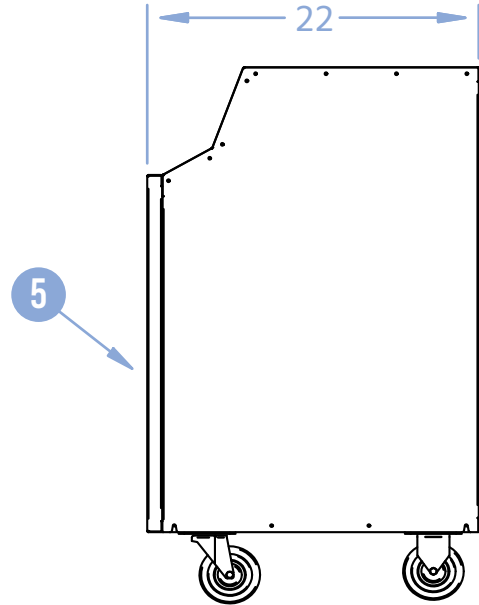
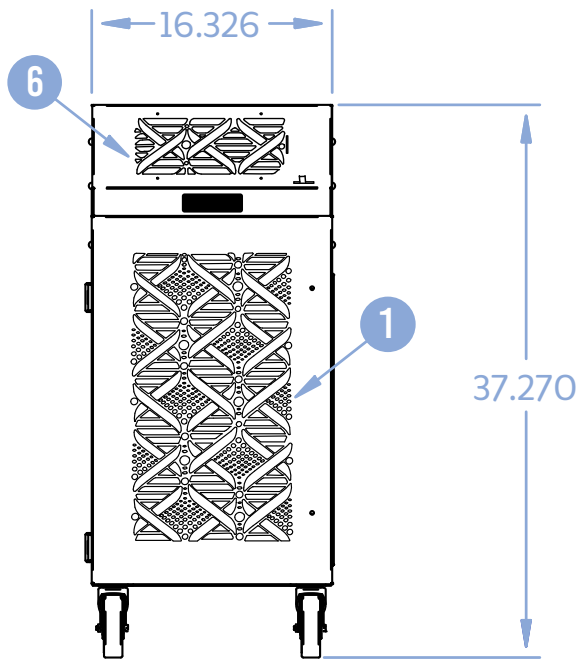

KBP600

LEGEND

- | | |
|---------------------------------|----------------------------|
| 1. Room Air Return | 4. Cord Storage |
| 2. Control Panel (Touch Pad) | 5. Filter Access Door |
| 3. Filtered Negative Air Supply | 6. Cleaned Room Air Supply |



ETL LISTED CONFORMS TO ANSI/UL1995
CERTIFIED TO CAN/CSA 22.2 NO 235